	Stadard No.	MODEL	NAME	REV.	PAGE
	PL-LCDM4000-007	LCDM-4000	Install Manual	1.01	1 of 10

INSTALL MANUAL

MODEL : LCDM-4000
REV. : 1.01
DATE : 2005. 05.10

 **PULOON Technology Inc.**

	Standard No.	MODEL	NAME	REV.	PAGE
	PL-LCDM4000-007	LCDM-4000	Install Manual	1.01	2 of 10

Revision History

Ver.	Date	Constents		Manager
		Cause of Revision	Details	
1.01	2005.05.01	Released by Puloon Lab.		

	Stadard No.	MODEL	NAME	REV.	PAGE
	PL-LCDM4000-007	LCDM-4000	Install Manual	1.01	3 of 10

Contents

1	Preview	4
2	Fixing Points.....	4
2.1	Left-sided Fixing Points from the Front View	4
2.2	Right-sided Fixing Points from the Front View	5
2.3	Fixing Points Location	6
3	Cable Connection	7
3.1	Power Connector	7
3.2	Communication Connector	7
3.3	Serial Communication Spec.	7
4	DIP Switch Setting.....	8
5	Loading Notes.....	8
5.1	Note Alignment	8
5.2	Loading Notes Inside the Cassette	9
5.3	Unlocking of Pusher	9
5.4	Cassette Insertion	10

	Stadard No.	MODEL	NAME	REV.	PAGE
	PL-LCDM4000-007	LCDM-4000	Install Manual	1.01	4 of 10

1 Preview

The Install Manual describes the installment of LCDM-4000.

2 Fixing Points

2.1 Left-sided Fixing Points from the Front View

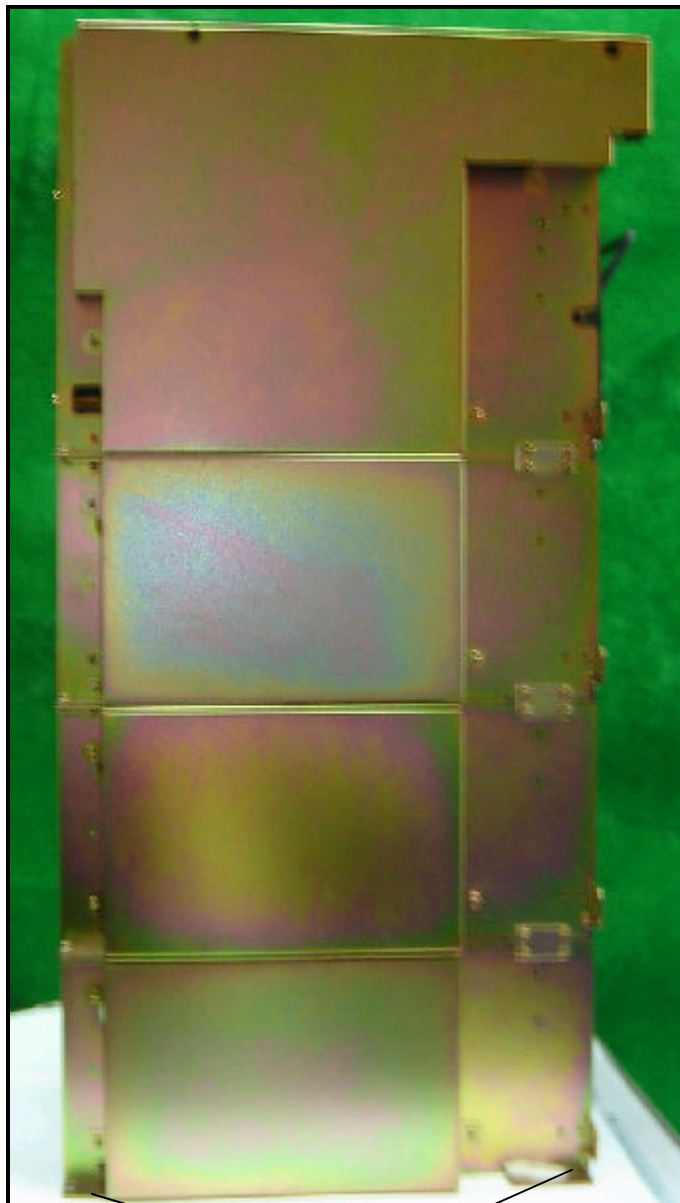

Fixing Points

	Stadard No.	MODEL	NAME	REV.	PAGE
	PL-LCDM4000-007	LCDM-4000	Install Manual	1.01	5 of 10

2.2 Right-sided Fixing Points from the Front View

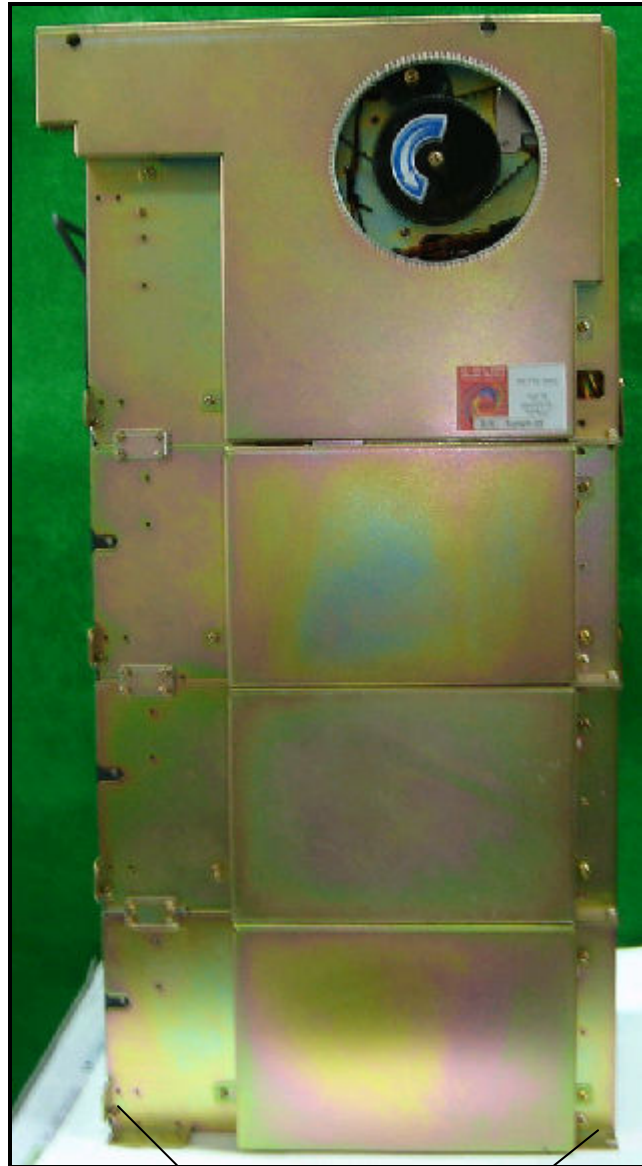

Fixing Points

	Stadard No.	MODEL	NAME	REV.	PAGE
	PL-LCDM4000-007	LCDM-4000	Install Manual	1.01	6 of 10

2.3 Fixing Points Location

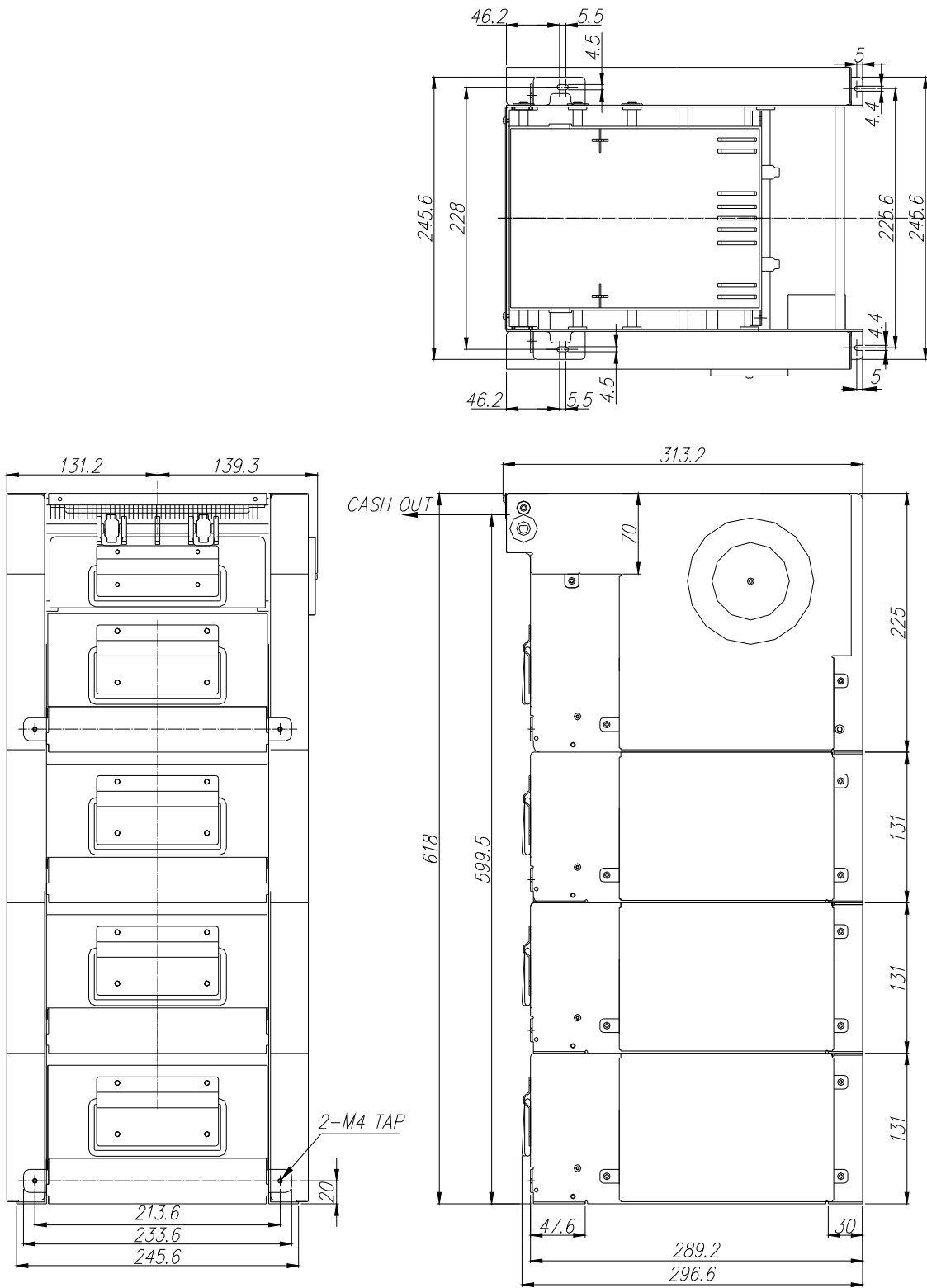

(210mm × 297mm)

	Stadard No.	MODEL	NAME	REV.	PAGE
	PL-LCDM4000-007	LCDM-4000	Install Manual	1.01	7 of 10

3 Cable Connection

3.1 Power Connector

The power connector is positioned at the bottom of the main controller.
Connector on Controller : MOLEX 5566VWO-02
Matching Connector : MOLEX 5557D-02

PIN No.	NAME
1	+24V
2	GND

3.2 Communication Connector

The communication connector is positioned at the bottom of main controller.
It is 9-way and D-type connector.

PIN NO.	NAME	FUNCTION
1		Not Used
2	RXD	Received Data
3	TXD	Transmitted Data
4		Not Used
5	GND	System Gnd
6		Not Used
7		Not Used
8		Not Used
9		Not Used

3.3 Serial Communication Spec.

Baud rate	9600 bps
Data bits	8 bits
Parity	No parity
Stop bits	1 stop bit

	Stadard No.	MODEL	NAME	REV.	PAGE
	PL-LCDM4000-007	LCDM-4000	Install Manual	1.01	8 of 10

4 DIP Switch Setting

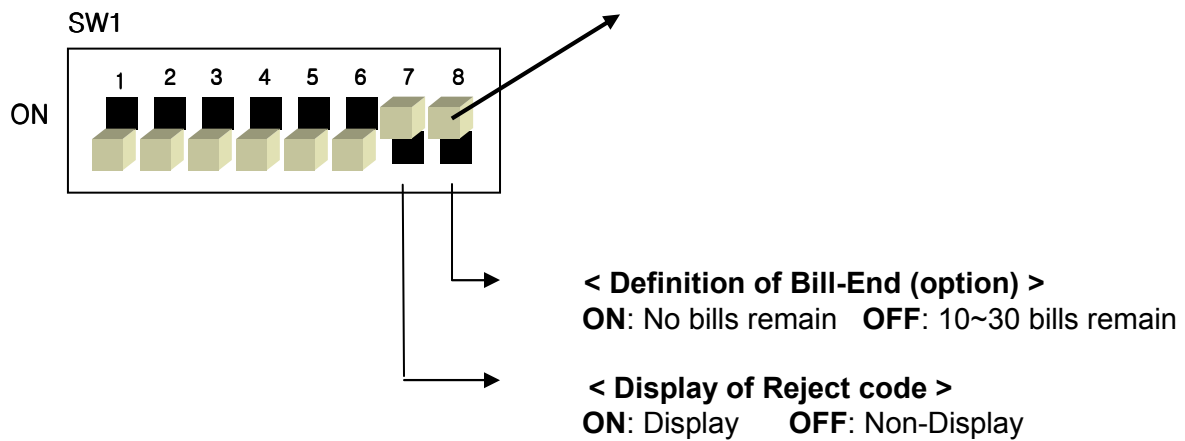

CAUTION !

Please push the reset switch(S4) after changing the Dip Switch

5 Loading Notes

The performance of LCDM is closely related to how to load the notes and the status of loading notes. The recommendation of loading notes are like the followings.

5.1 Note Alignment

Before loading notes, the note alignment is recommended like the picture in the bewlow. At the same time, the pusher should be locked and placed like the picture.

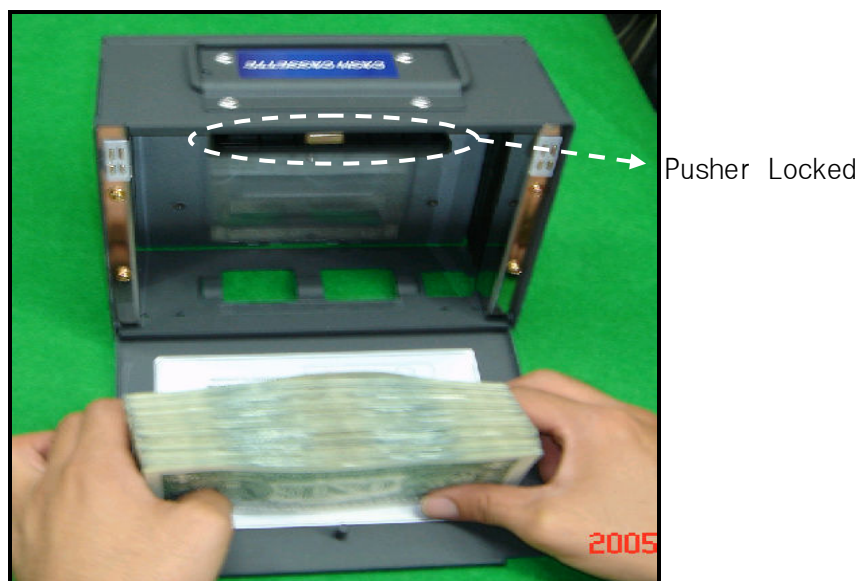

	Stadard No.	MODEL	NAME	REV.	PAGE
	PL-LCDM4000-007	LCDM-4000	Install Manual	1.01	9 of 10

5.2 Loading Notes Inside the Cassette



5.3 Unlocking of Pusher

Complete note loading unlocking the pusher like the picture.



	Stadard No.	MODEL	NAME	REV.	PAGE
	PL-LCDM4000-007	LCDM-4000	Install Manual	1.01	10 of 10

5.4 Cassette Insertion

Cash Cassettes should be pushed until the end of the main body of LCDM.

